

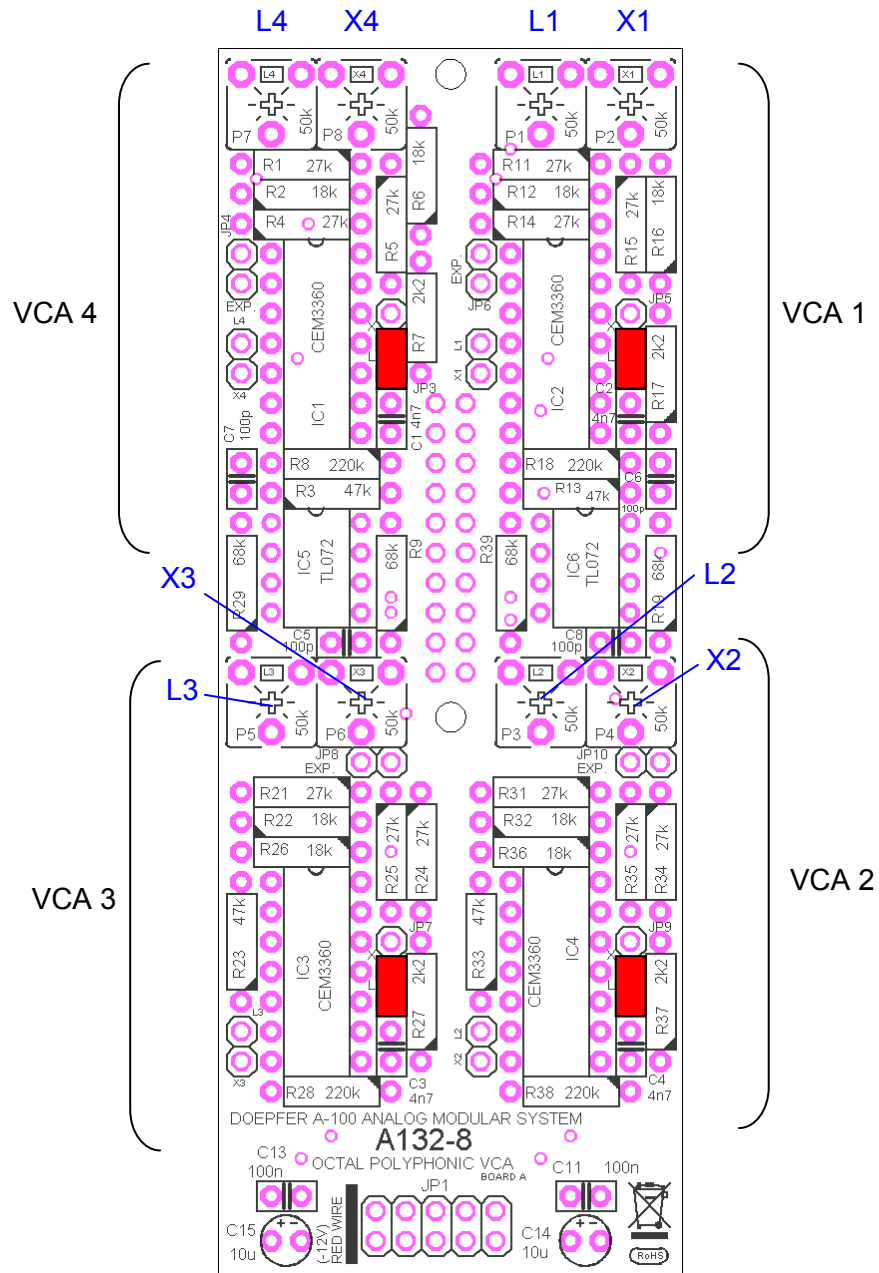

A-132-8 Octal Polyphonic VCA

Position and function of the trimming potentiometers, jumpers and connectors Board A
Versions 1 and 2

trimming potentiometer for CV input



 = jumper positions for linear control scales of the second VCAs

For experts only:

The terminals (pin headers) labelled L1, X1, L2, X2, L3, X3, L4 and X4 can be used for the adjustment of the CV inputs with the trimming potentiometers. For this the max. CV voltage has to be applied to the CV socket in question (e.g. +5V) and then the voltage at the corresponding pin adjusted with the corresponding trimming potentiometer to about +1.6V.

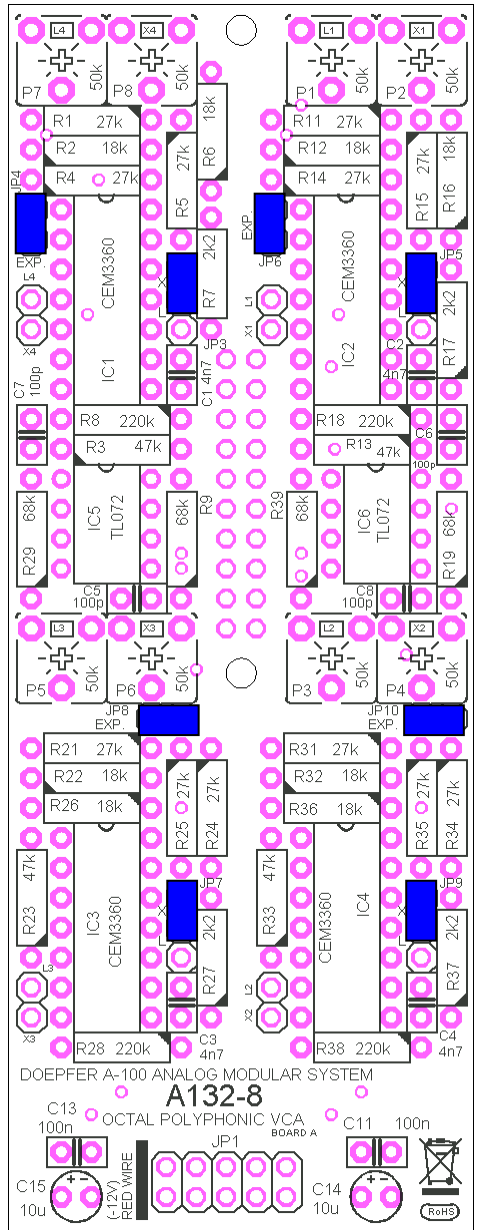

 = jumper positions for exponential scales of the second VCAs

A-102-0 Octal Polyphonic VCA
Position and function of the jumpers and connectors Board B (top side)
Version 1

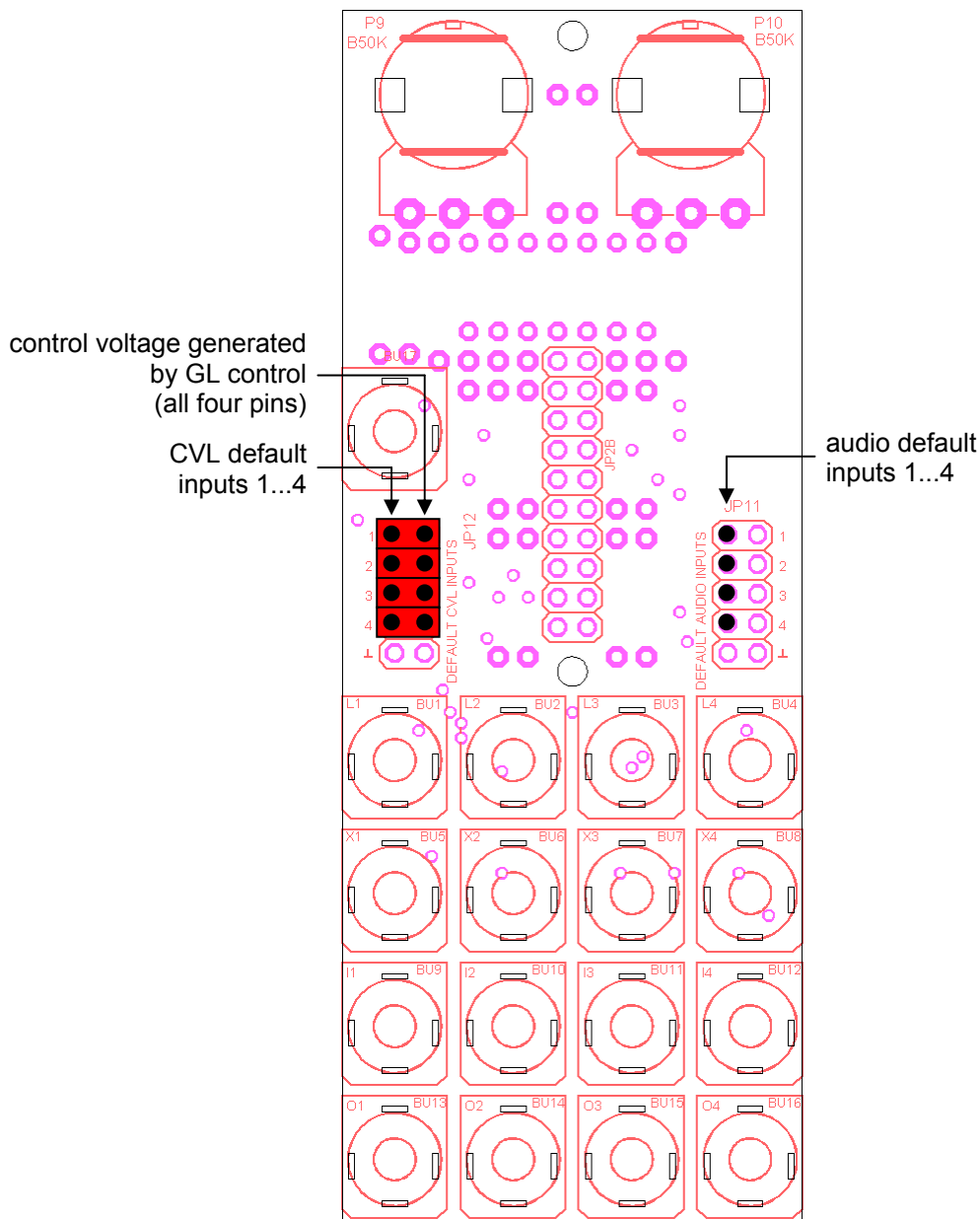

Function of JP12:

JP12 is used for the internal connection of the voltage generated by the GL control to the switching contacts of the sockets CVL1...CVL4. The above picture shows the default setting of the JP12 jumpers (factory setting). The four right upper pins of JP12 are wired to the internal voltage generated by the GL control. The four left upper pins of JP12 are wired to the switching contacts of the sockets CV L1...CV L4. With the jumpers as shown in the picture the GL voltage is connected to the switching contacts of the sockets CV L1...CV L4.

If desired the jumpers can be removed and other default voltages connected to the corresponding pins (e.g. the outputs of the polyphonic envelope generator A-141-4 or a polyphonic CV interface). For this the four left upper pins of JP12 labelled 1...4 have to be used. The two lower pins of JP12 are hard-wired to GND.

Function of JP11:

JP11 can be used to connect the switching contacts of the sockets Audio In 1...4 to four default audio signals (e.g. the four audio outputs of the polyphonic filter A-105-4). For this the four left upper pins of JP11 have to be used (not the right pins !).

If desired the jumpers can be removed and other default voltages connected to the corresponding pins (e.g. the outputs of the polyphonic envelope generator A-141-4 or a polyphonic CV interface). For this the four left upper pins of JP12 labelled 1...4 have to be used. The two lower pins of JP12 are hard-wired to GND.

A-142-0 Octal Polyphonic VCA
Position and function of the jumpers and connectors Board B (top side)
Version 2

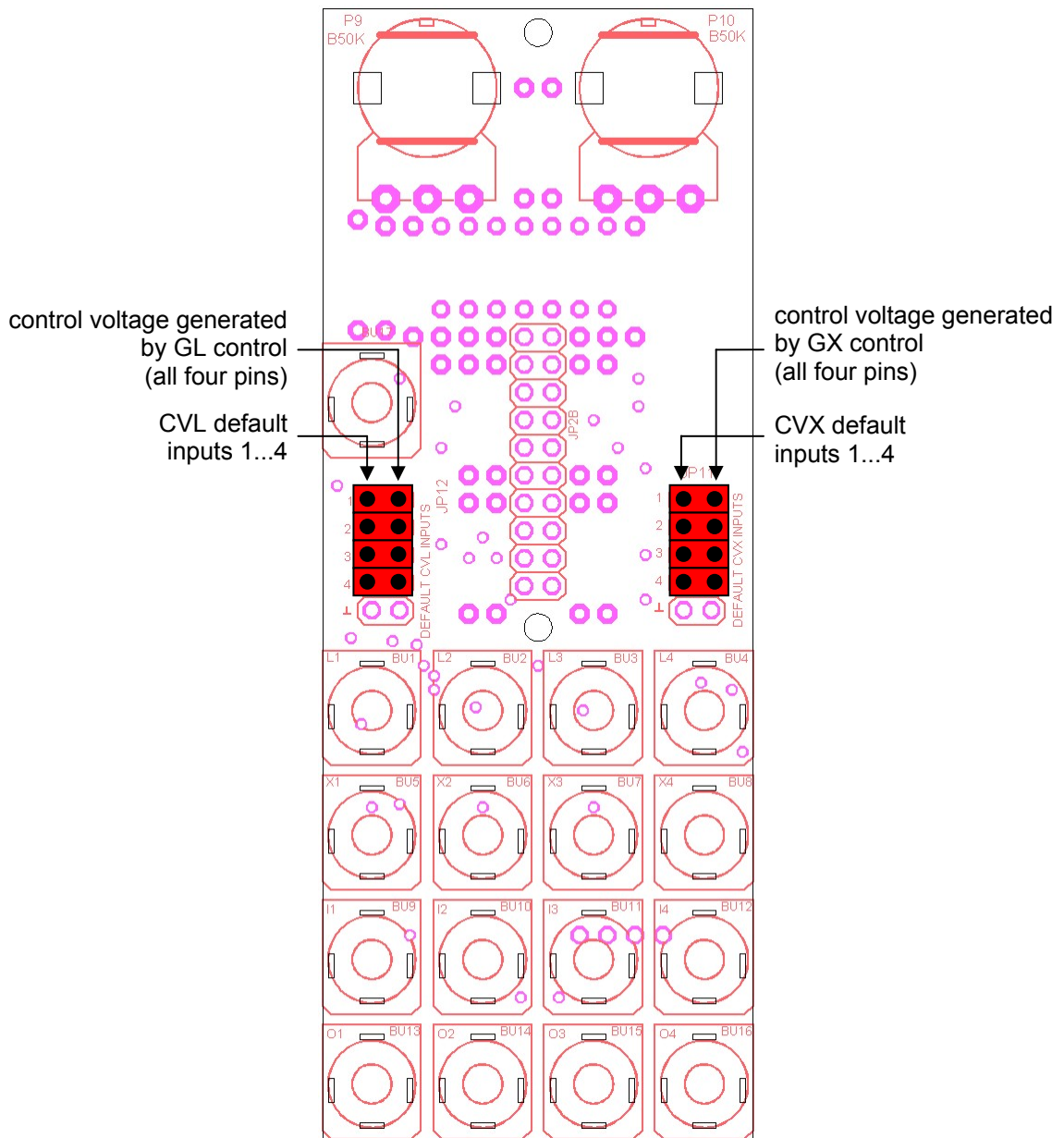

Function of JP12:

JP12 is used for the internal connection of the voltage generated by the GL control to the switching contacts of the sockets CVL1...CVL4. The above picture shows the default setting of the JP12 jumpers (factory setting). The four right upper pins of JP12 are wired to the internal voltage generated by the GL control. The four left upper pins of JP12 are wired to the switching contacts of the sockets CV L1...CV L4. With the jumpers as shown in the picture the GL voltage is connected to the switching contacts of the sockets CV L1...CV L4.

If desired the jumpers can be removed and other default voltages connected to the corresponding pins (e.g. the outputs of the polyphonic envelope generator A-141-4 or a polyphonic CV interface). For this the four left upper pins of JP12 labelled 1...4 have to be used. The two lower pins of JP12 are hard-wired to GND.

Function of JP11:

JP11 is used for the internal connection of the voltage generated by the GX control to the switching contacts of the sockets CVX1...CVX4. The above picture shows the default setting of the JP11 jumpers (factory setting). The four right upper pins of JP11 are wired to the internal voltage generated by the GX control. The four left upper pins of JP11 are wired to the switching contacts of the sockets CV X1...CV X4. With the jumpers as shown in the picture the GX voltage is connected to the switching contacts of the sockets CV X1...CV X4.

If desired the jumpers can be removed and other default voltages connected to the corresponding pins (e.g. the outputs of the polyphonic envelope generator A-141-4 or a polyphonic CV interface). For this the four left upper pins of JP12 labelled 1...4 have to be used. The two lower pins of JP12 are hard-wired to GND.

A132-8 Octal Polyphonic VCA
Position and function of the jumpers and connectors Board B (bottom side)
Version 2

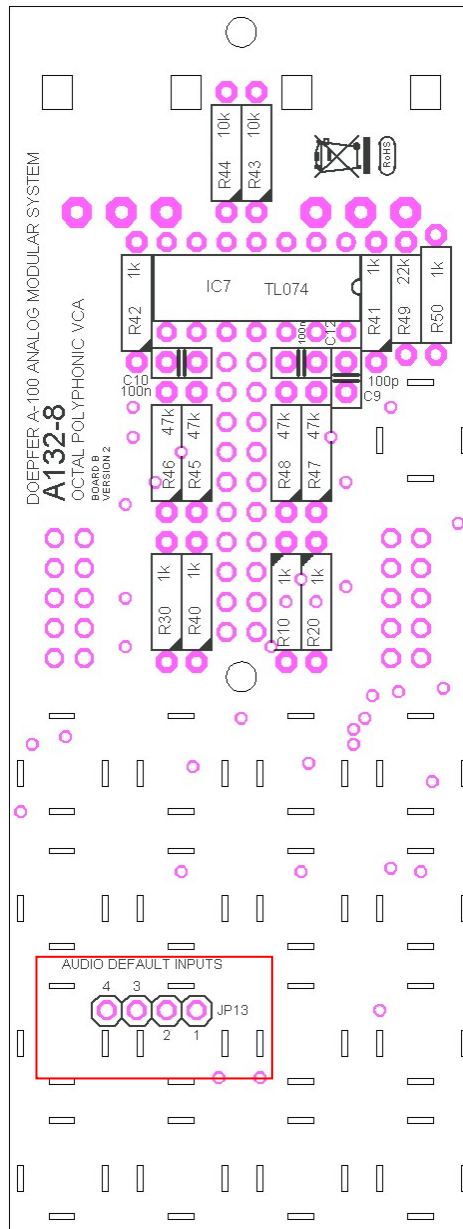

Function of JP13:

JP13 can be used to connect the switching contacts of the sockets Audio In 1...4 to four default audio signals (e.g. the four audio outputs of the polyphonic filter A-105-4).

For the internal wiring of the pins of JP11/JP12/JP13 single wire cables with female connectors on both sides can be used (available in electronic shops, e.g. used for Arduino or Raspberry Pi boards).

For the dual row pin headers even 10 pin female IDC connectors with ribbon cables may be used if one pays attention to the correct polarity.

Note

To establish the internal connections the two pc boards of the module and the front panel have to be disassembled temporarily. Pay attention to the correct alignment of the connectors, that are used to connect the two boards, when the module is re-assembled !